

# LCM Specification

Preliminary specification

Final Specification

Project No. 项目编号	TFT-H080A1SVTHX3R50		
Customer 客户名称			
Module No. 客户型号			
Product type 产品内容	TFT LCD Module 800 x 3RGB x 600Dots 8.0" TFT LCD		
Signature by customer: 客户确认签章:			
<input type="checkbox"/> Trial production		<input type="checkbox"/> Mass production	
编 制	电子审核	结构审核	批 准
Y. L			

深圳市鑫洪泰电子科技有限公司

Shenzhen Hot Display Technology Co., Ltd

**1 Document revision history :**

DOCUMENT REVISION	DATE	DESCRIPTION	PREPARED BY	APPROVED BY
0	2020-05-14	First Release.	Y.L	

## 1. General Feature:

Item	Standard Value	Unit
Display Size	8.0"	--
Number of Pixels	800(H)x3(RGB)*600(V)	--
Active Area	162.00(H) * 121.50(V)	mm
Outline Dimension	182.90(H) × 141.00(V) × 7.00(D)	mm
Viewing Direction	12 O'Clock	-
Interface	TTL 18/24 bit	-
Panel Driver IC	HX8264+HX8696	-
Panel Driver Condition	VDD=3.3V	V
Backlight	White LED	-
Touch Panel	With RTP	-
Cap Touch Driver IC	---	-
Cap Touch Driver Condition	---	V
Operation Temperature	-20~70	°C
Storage Temperature	-30~80	°C

## 2. Outline Dimensions

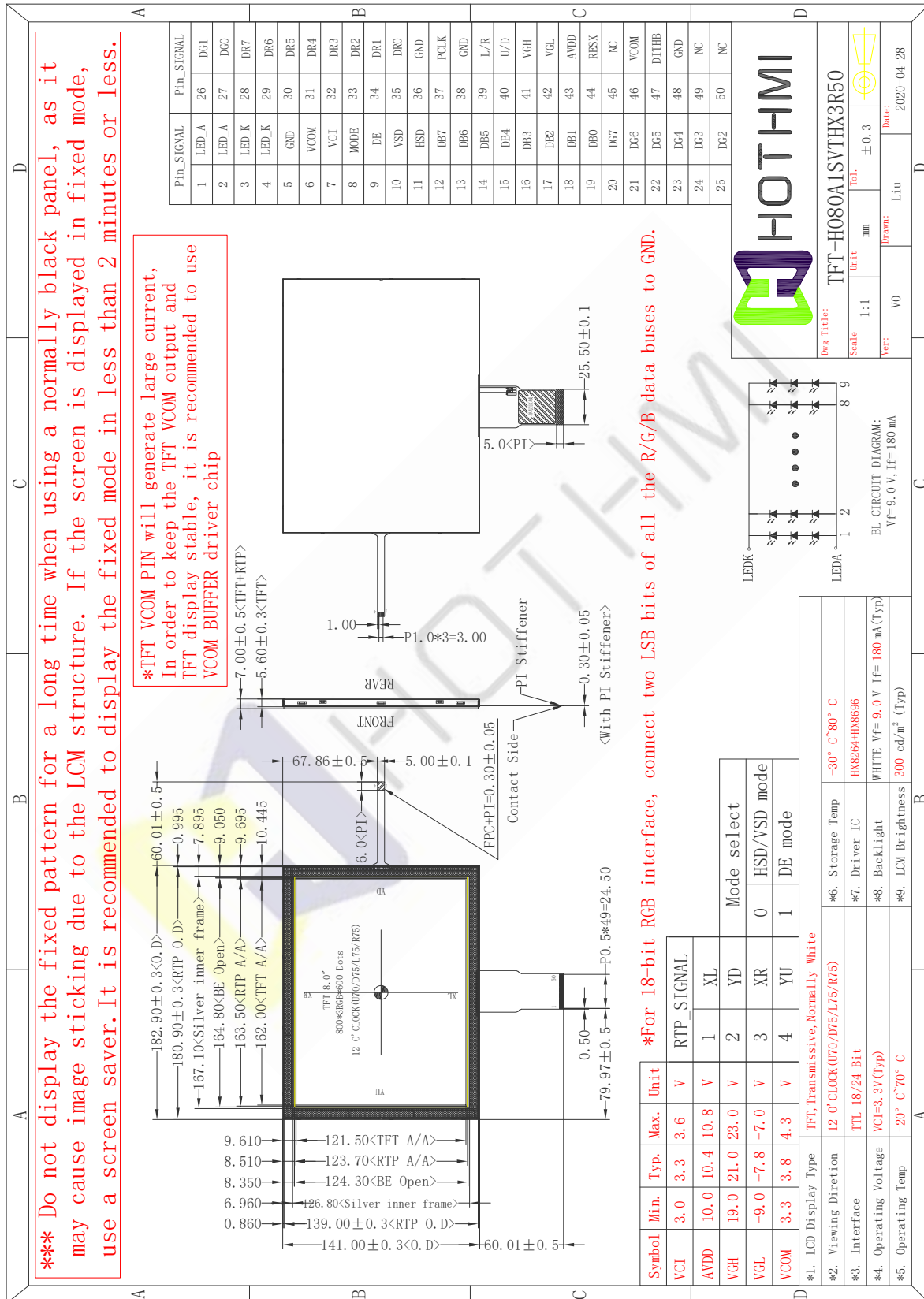

### 3. Pin Description

#### 3.1 Pin Description

Pin NO.	Symbol	Description
1,2	LED_A	LED Anode(+9.0V/180mA)
3,4	LED_K	LED Cathode
5	GND	Ground
6	VCOM	TFT Common Electrode Voltage
7	VDD	Analog Power(2.5 ~ 3.6 V)
8	MODE	DE / SYNC mode select under TTL mode. Normally pull high MODE=VDD : DE mode; MODE=GND : HSD/VSD mode.
9	DE	Input data enable control
10	VSD	Vertical sync input with negative polarity
11	HSD	Horizontal sync input with negative polarity
12-19	DB7-DB0	Blue data bus
20-27	DG7-DG0	Green data bus
28-35	DR7-DR0	Red data bus
36	GND	Ground
37	PCLK	Clock signal for data latching
38	GND	Ground
39	L/R	Source Right or Left sequence control. Normally pull high. SHLR = "L", shift left; SHLR = "H", shift right
40	U/D	Gate Up or Down scan control. Normally pull low. UPDN = "L", From top to bottom; UPDN = "H", From bottom to top.
41	VGH	Power supply for drive output High
42	VGL	Power supply for drive output Low
43	AVDD	Power supply for analog circuits
44	RESET	Global reset pin.Active low to enter Reset State. Suggest to connecting with an RC reset circuit for stability.
45	NC	No Connect
46	VCOM	TFT Common Electrode Voltage
47	DITHB	Dithering function enable control. Normally pull low DITHER = "1", Disable internal dithering function. DITHER = "0", Enable internal dithering function
48	GND	Ground
49,50	NC	No Connect
-END-		

### 3.2 Wiring Diagram

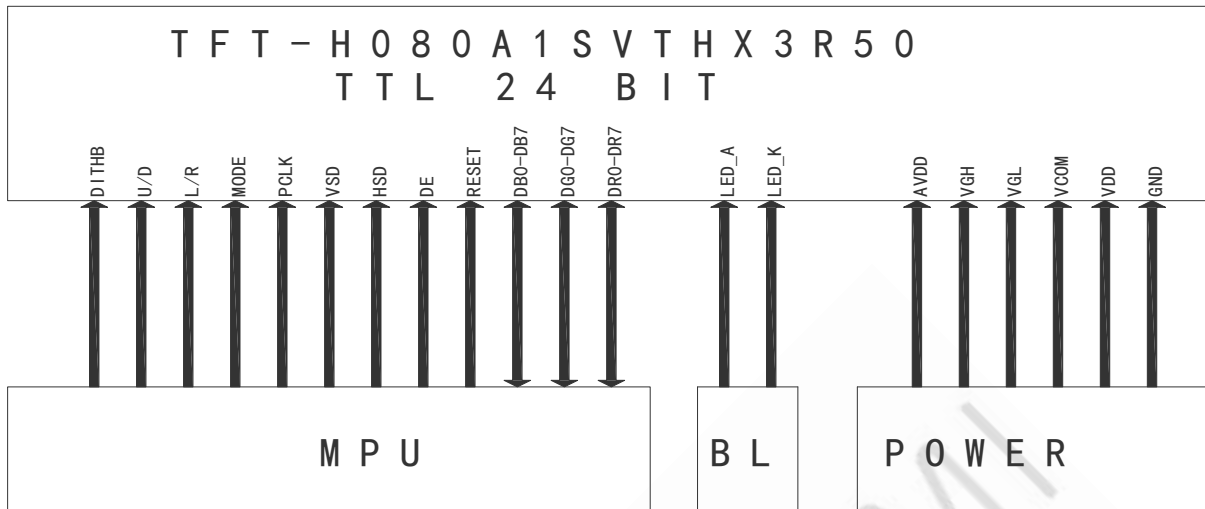

## 4. Electrical Characteristics

### 4-1 TFT LCD Module Operating Conditions

Item	Symbol	Condition	Min	Type	Max	Unit
Analog Power supply	VCI	-	3.0	3.3	3.6	V
Power For Analog Circuit	AVDD	-	-	10.4	-	V
TFT Gate on voltage	VGH	VGH-VGL	-	21.0	-	V
TFT Gate off voltage	VGL	<=40V	-	-7.8	-	V
TFT Common Electrode Voltage	VCOM	-	3.4	3.8	4.2	V

**Note:** TFT VCOM PIN will generate large current. In order to keep the TFT VCOM output and TFT display stable, it is recommended to use VCOM BUFFER driver chip

### 4-2 LED back light specification (per chip)

Item	Symbol	Condition	Min	Type	Max	Unit
Forward voltage	Vt	If=20mA	8.4	9.0	9.6	V
Forward current	Ipn	/1-chip	-	180	-	mA
Luminance(With LCD)	Lv	If=180mA	-	300	-	cd/m <sup>2</sup>
Luminous color	White					

## 5. OPTICAL SPECIFICATION

The test of Optical specifications shall be measured in a dark room (ambient luminance 1lux and temperature = 25 ± 2°C) with the equipment of Luminance meter system (Goniometer system and TOPCON BM-5) and test unit shall be located at an approximate distance 50cm from the LCD surface at a viewing angle of  $\theta$  and  $\Phi$  equal to 0°. The center of the measuring spot on the Display surface shall stay fixed. The backlight should be operating for 30 minutes prior to measurement.

Parameter		Symbol	Condition	Min.	Typ.	Max.	Unit	Remark
Viewing Angle Range	Horizontal	$\Theta$ L	CR>10	-	75	-	Deg.	Note 1
		$\Theta$ R		-	75	-	Deg.	
	Vertical	$\Theta$ U		-	70	-	Deg.	
		$\Theta$ D		-	75	-	Deg.	
Contrast ratio		CR	$\Theta = 0^\circ$	-	500	-		Note2
Color Gamutt (C light)		CG		-	50	-	%	
White Chromaticity		Wx	$\Theta = 0^\circ$	-0.03	0.293	+0.03		Note4 (Based on C Light)
		Wy			0.323			
Reproduction of color	Red	Rx			0.616			
		Ry			0.335			
	Green	Gx			0.284			
		Gy			0.538			
	Blue	Bx			0.148			
		By			0.141			
Response Time (Rising + Falling)		Tr+Tf	$\Theta = 0^\circ$ Ta= 25°C	-	20	30	ms	Note5
Transmittance		Tr		-	6.4		%	Note3

Note :

1. Viewing angle is the angle at which the contrast ratio is greater than 10. The viewing angles are determined for the horizontal or 3, 9 o' clock direction and the vertical or 6, 12 o' clock direction with respect to the optical axis which is normal to the LCD surface (see FIGURE 5).

2. Contrast measurements shall be made at viewing angle of  $\Theta = 0$  and at the center of the LCD surface. Luminance shall be measured with all pixels in the view field set first to white, then to the dark (black) state . (see FIGURE 5) Luminance Contrast Ratio (CR) is defined mathematically.

CR =Luminance when displaying a white raster / Luminance when displaying a black raster

3. Transmittance is the Value with Polarizer.

4. The color chromaticity coordinates specified in the above table shall be calculated from the spectral data measured with all pixels first in red, green, blue and white. Measurements shall be made at the center of the panel.

5. The electro-optical response time measurements shall be made as FIGURE 6 by switching the “data” input signal ON and OFF. The times needed for the luminance to change from 10% to 90% is  $T_r$ , and 90% to 10% is  $T_d$ .

**Figure 4. The Definition of  $V_{th}$  &  $V_{sat}$**

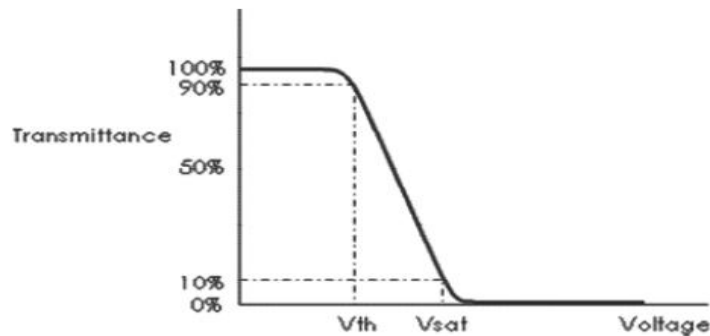

**Figure 5. Measurement Set Up**

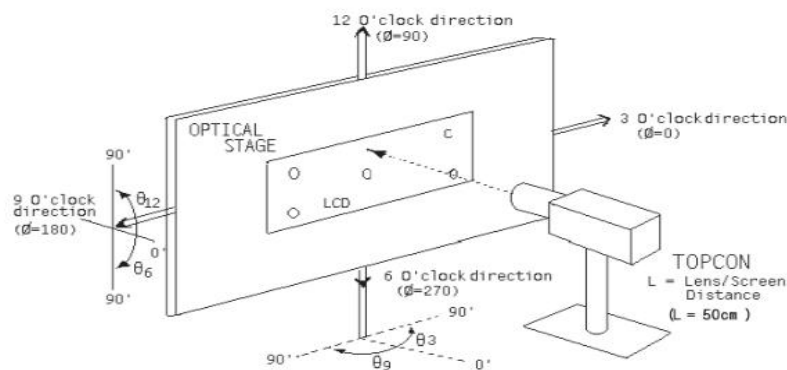

**Figure 6. Response Time Testing**

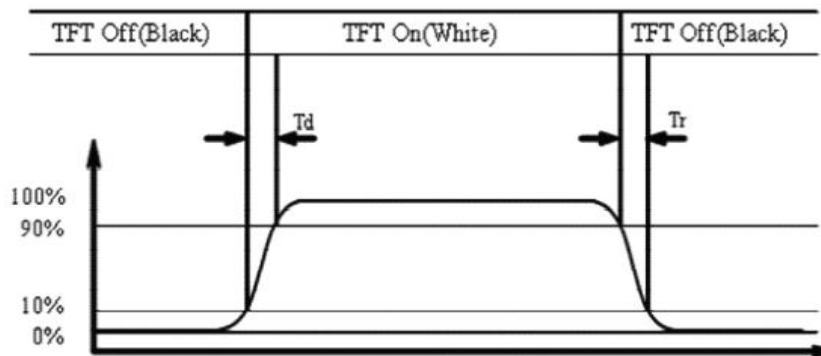



## 6. Timing Characteristics of Input Signals

### 6-1 AC electrical characteristics

Parameter	Symbol	Spec.			Unit
		Min.	Typ.	Max.	
HS setup time	$T_{hst}$	8	-	-	ns
HS hold time	$T_{hhd}$	8	-	-	ns
VS setup time	$T_{vst}$	8	-	-	ns
VS hold time	$T_{vhd}$	8	-	-	ns
Data setup time	$T_{dsu}$	8	-	-	ns
Data hold time	$T_{dhd}$	8	-	-	ns
DE setup time	$T_{esu}$	8	-	-	ns
DE hold time	$T_{ehd}$	8	-	-	ns
VDD Power On Slew rate	$T_{POR}$	-	-	20	ms
RSTB pulse width	$T_{Rst}$	10	-	-	us
CLKIN cycle time	$T_{cph}$	20	-	-	ns
CLKIN pulse duty	$T_{cwh}$	40	50	60	%
Output stable time	$T_{sst}$	-	-	6	us

### 6-2 Data input format

- Horizontal timing

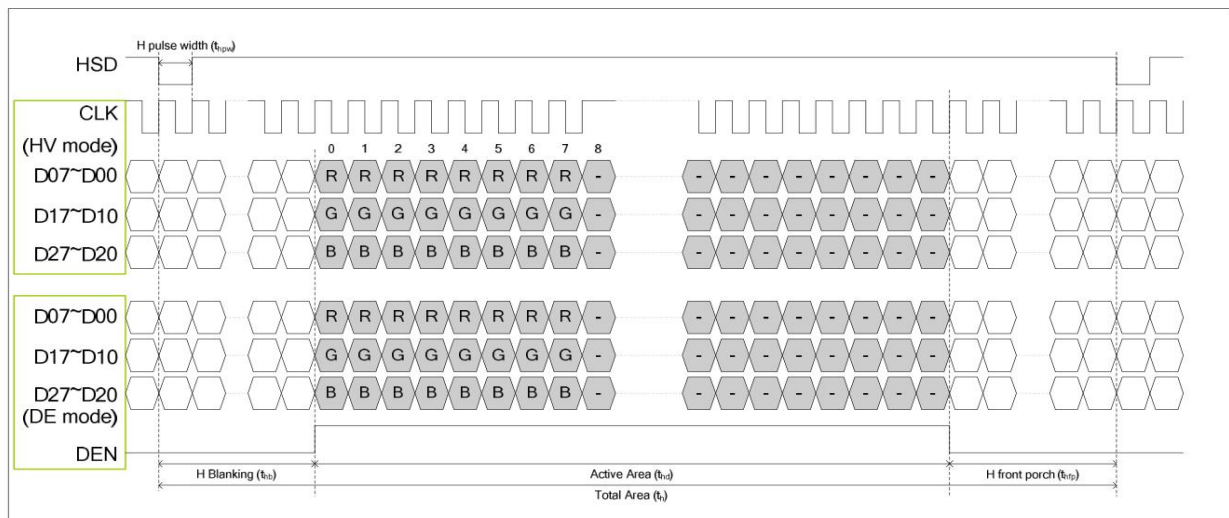

- Vertical timing

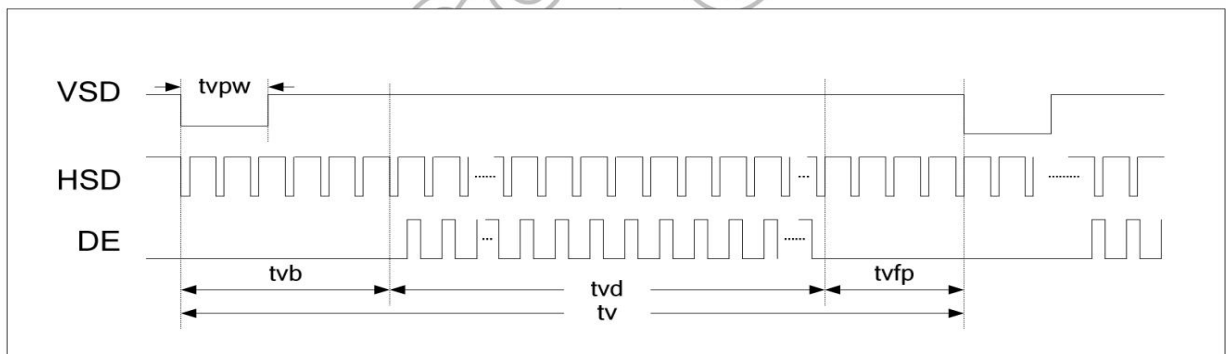

● **Horizontal timing**

Parameter	Symbol	Spec.			Unit
		Min.	Typ.	Max.	
Horizontal Display Area	thd		800		DCLK
DCLK frequency	fclk	-	40	50	MHz
One Horizontal Line	th	862	1056	1200	DCLK
HS pulse width	thpw	1	-	40	DCLK
HS Back Porch (Blanking)	thb		46		DCLK
HS Front Porch	thfp	16	210	354	DCLK
DE mode Blanking	th-thd	62	256	400	DCLK

● **Vertical timing**

Parameter	Symbol	Spec.			Unit
		Min.	Typ.	Max.	
Vertical Display Area	tvd		600		T <sub>H</sub>
VS period time	tv	624	635	700	T <sub>H</sub>
VS pulse width	tvpw	1	-	20	T <sub>H</sub>
VS Back Porch (Blanking)	tvb		23		T <sub>H</sub>
VS Front Porch	tvfp	1	12	77	T <sub>H</sub>
DE mode Blanking	tv-tvd	24	35	100	T <sub>H</sub>

**6-2 Timing diagram**

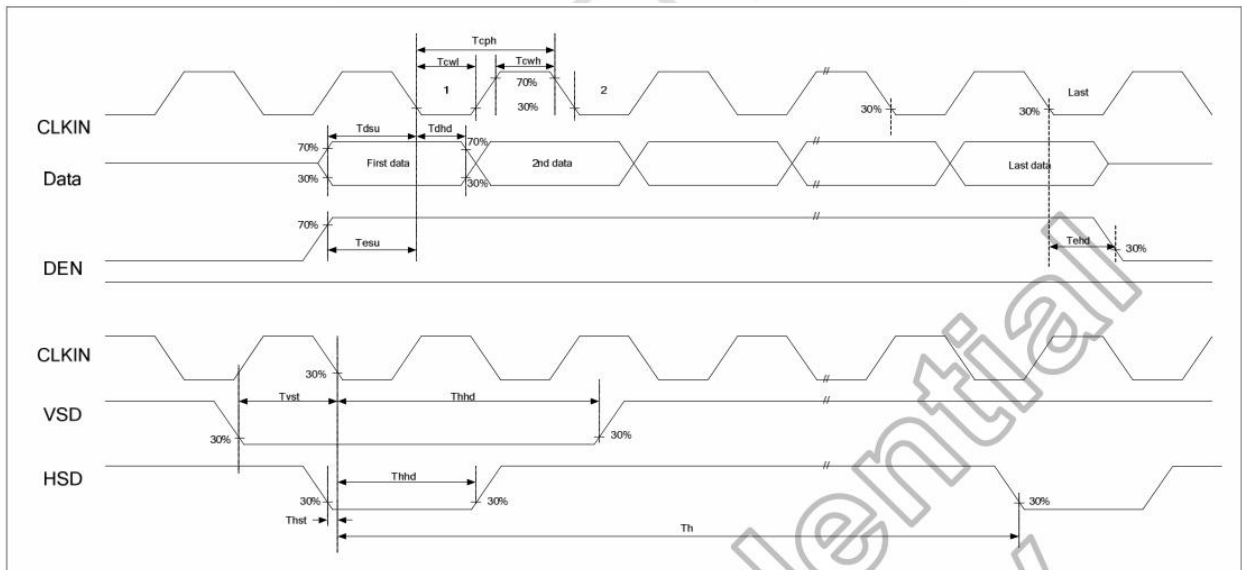

## 7. RELIABILITY TEST

### 7-1 Temperature and Humidity

TEST ITEMS	CONDITIONS	NOTE
High Temperature Operation	70°C ; 120hrs	
High Temperature Storage	80°C ; 120hrs	
High Temperature High Humidity Operation	60°C; 90%RH ; 120hrs (No condensation)	
Low Temperature Operation	-20°C ; 120hrs	
Low Temperature Storage	-30°C ; 120hrs	
Thermal Shock	-30°C (0.5hr) ~ 80°C (0.5hr) ; 100 Cycles	Non-Operating
Image Sticking	25°C ; 2hrs	1

Note 1:

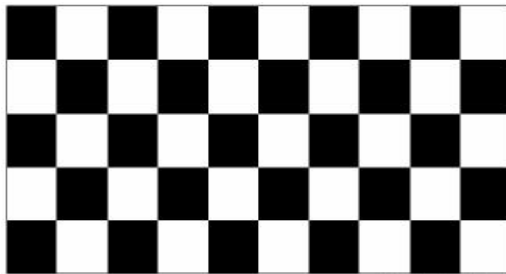

(a) Test Pattern (chess board Pattern )



(b) Gray Pattern

### 7-2 Shock and Vibration

ITEMS	CONDITIONS
Packing Shock (Non-Operation)	<ul style="list-style-type: none"> <li>● Shock level:980m/s<sup>2</sup></li> <li>● Waveform:1/2 Sine wave,6msec</li> <li>● ±X, ±Y ±Z,each axis 1 times</li> </ul>
Packing Vibration (Non-Operation)	<ul style="list-style-type: none"> <li>● Frequency range:8-33.3HZ</li> <li>● Stoke:1.0mm</li> <li>● Sweep: 10Hz-50Hz</li> <li>● x,y,z 2 hours for each direction</li> </ul>

### 7-3 Electrostatic Discharge

TEST ITEM	CONDITIONS
ESD (Non-operation)	150pF,330 Ω , Contact±4KV,Air :±8KV.Note 1
	200pF,0 Ω , ±200V Contact test.Note 2

Note:Measure Point:

- 1.LCD glass and metal bezel
- 2.IF connector pins

## 8.HANDDLING & CAUTIONS

### 8-1 Caution For Operation

◆Since the LCM is made of glass, do not apply strong mechanical impact or static load onto it. Handling with care since shock, vibration, and careless handling may seriously affect the product. If it falls from a high place or receives a strong shock, the glass maybe broken.

◆It is indispensable to drive the LCM within the specified voltage limit since the higher voltage than the limit causes LCM's life shorter. An electro-chemical reaction due to DC causes undesirable deterioration of the LCM so that the use of DC drive should avoid.

◆Do not connect or disconnect the LCM to or from the system when power is on.

◆Never use the LCM under abnormal conditions of high temperature and high humidity.

◆When expose to drastic fluctuation of temperature(hot to cold or cold to hot), the LCM may be affected; specifically, drastic temperature fluctuation from cold to hot, produces dew on the LCM's surface which may affect the operation of the polarizer on the LCM.

◆Response time will be extremely delay at lower temperature than the operating temperature range and on the other hand LCM may turn black at temperature above its operational range. However those phenomenon do not mean malfunction or out of order with the LCM. The LCM will revert to normal operation once the temperature returns to the recommended temperature range for normal operation.

◆Do not display the fixed pattern for a long time when using a normally black panel, as it may cause image sticking due to the LCM structure. If the screen is displayed in fixed mode, use a screen saver. It is recommended to display the fixed mode in less than 2 minutes or less.

◆Do not disassemble and/or re-assemble LCM module

### 8-2 Caution Against Static Charge

◆The LCM use C-MOS LSI drivers, so customers are recommended that any unused input terminal would be connected to Vdd or Vss, do not input any signals before power is turn on, and ground you body, work/assembly area, assembly equipments to protect against static electricity.

◆Remove the protective film slowly, keeping the removing direction approximate 30-degree not vertical from panel surface, if possible, under ESD control device like ion blower, and the humidity of working room should be kept over 50%RH to reduce the risk of static charge.

◆Avoid the use work clothing made of synthetic fibers. We recommend cotton clothing or other conductivity-treated fibers.

◆In handling the LCM, wear non-charged material gloves. And the conducting wrist to the earth and the conducting shoes to the earth are necessary

## 9.LCD display initialization code

**This product does not require initialization code driver**

**-END-**